

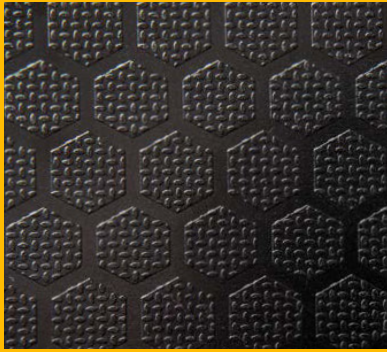

## VAN UPFIT PREP

Preparing for the installation  
of your upfit made easier



**EFFICIENCY**

Easy install that prevents damage to the factory floor.



**SAFETY**

Extruded aluminum joints where floor pieces meet.



**QUICK INSTALL**

Our install kits simplify your installation.

# VAN UPFIT PREP

**VAN FLOORS**

CHEVROLET EXPRESS. . . . .P. 24  
 FORD TRANSIT. . . . . P. 27  
 FORD TRANSIT CONNECT. . . . . P. 24  
 GMC SAVANA. . . . . P. 25  
 MERCEDES-BENZ SPRINTER . . . . . P. 26  
 RAM PROMASTER . . . . . P. 27

**INSTALL KITS**

DRIVER. . . . .P. 28  
 PASSENGER. . . . . P. 29

VAN FLOORS

- › Easy to install with integrated mounting tracks
- › Compatible with Ranger Design’s shelving packages
- › Custom fit for almost all vans
- › Includes aluminum sills at the side and rear doors
- › No thermal expansion
- › Much safer due to load distribution
- › Quieter ride – reduces noise for the cargo area
- › 3 year warranty



# VAN UPFIT PREP – FLOORS

VAN UPFIT PREP

**IT'S MORE THAN A FLOOR!**



**CHEVROLET EXPRESS**

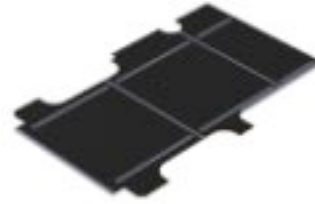

**6540-GSR**

Chevrolet Express Floor

**Marine-Grade Plywood**

135"

74 lbs

1 hr

Yes

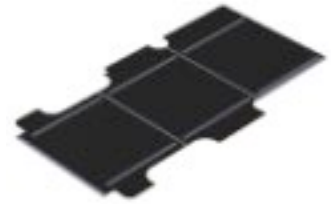

**6540-GSX**

Chevrolet Express Floor

**Marine-Grade Plywood**

155" Ext.

89 lbs

1 hr

Yes



**FORD TRANSIT CONNECT**



**6540-FCS**

Ford Transit Connect Floor

**Marine-Grade Plywood**

105"

33 lbs

0.7 hr

Yes



**6540-FCL**

Ford Transit Connect Floor

**Marine-Grade Plywood**

120.5"

42 lbs

0.7 hr

Yes

Impact and puncture resistant floors preserve the cargo van interior





# VAN UPFIT PREP – FLOORS

VAN UPFIT PREP

Professional details – A clean, professional look that’s easy to maintain.



**GMC**  
SAVANA

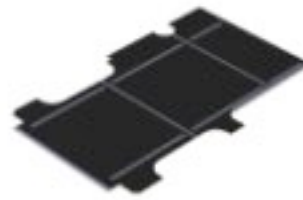

**6540-GSR**

GMC Savana Floor

**Marine-Grade Plywood**

135"

74 lbs

1 hr

Yes

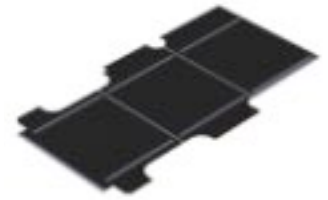

**6540-GSX**

GMC Savana Floor

**Marine-Grade Plywood**

155"

89 lbs

1 hr

Yes



**PROTECTION**

Rigid floor covering protects cargo van floors from impact damage and scratches.

# THE PERFECT FLOOR FOR YOUR ELECTRIC VAN

Ranger Design's unique E-Floor is designed to offer the best fit for both electric and gas powered vehicles. Its revolutionary concept offers an easy install that avoids all the wiring that runs just below the surface of the vehicle's OEM floor. This option also ensures a great resale value for your van in the future, as it leaves no permanent damage. As sturdy and effective as a regular floor, it simply offers more benefits for your EV!



### 6541-DR

Mercedes-Benz Sprinter E-Floor

<b>Marine-Grade Plywood</b>
144"
82 lbs
1 hr



### 6541-DL

Mercedes-Benz Sprinter E-Floor

<b>Marine-Grade Plywood</b>
170"
111 lbs
1 hr



### 6541-DX

Mercedes-Benz Sprinter E-Floor

<b>Marine-Grade Plywood</b>
170" Ext.
121 lbs
1 hr

**MERCEDES-BENZ**  
SPRINTER



**FORD  
TRANSIT**



**6541-FTS**

Ford Transit E-Floor

**Marine-Grade Plywood**

130"

70 lbs

1 hr

Yes



**6541-FTL**

Ford Transit E-Floor

**Marine-Grade Plywood**

148"

88 lbs

1 hr

Yes



**6541-FTX**

Ford Transit E-Floor

**Marine-Grade Plywood**

148" Ext.

109 lbs

1.3 hrs

Yes



**RAM  
PROMASTER**



**6541-PS**

RAM ProMaster E-Floor

**Marine-Grade Plywood**

118"

71 lbs

1 hr

Yes



**6541-PM**

RAM ProMaster E-Floor

**Marine-Grade Plywood**

136"

83 lbs

1 hr

Yes



**6541-PL**

RAM ProMaster E-Floor

**Marine-Grade Plywood**

159"

100 lbs

1 hr

Yes



**6541-PX**

RAM ProMaster E-Floor

**Marine-Grade Plywood**

159" Ext.

112 lbs

1.3 hrs

Yes

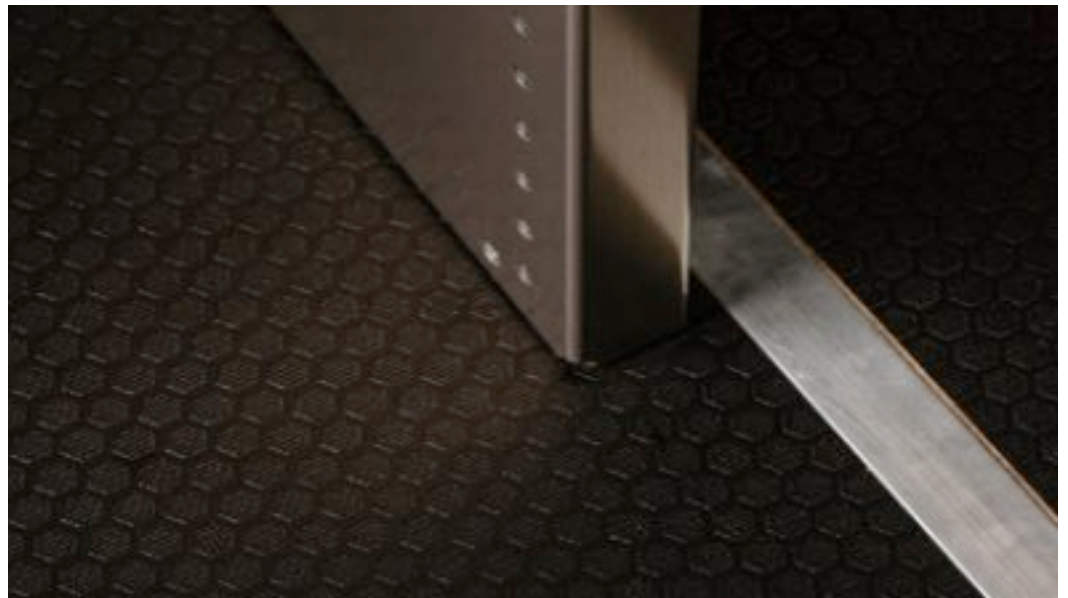

# VAN UPFIT PREP – INSTALL KITS

## INSTALL KITS



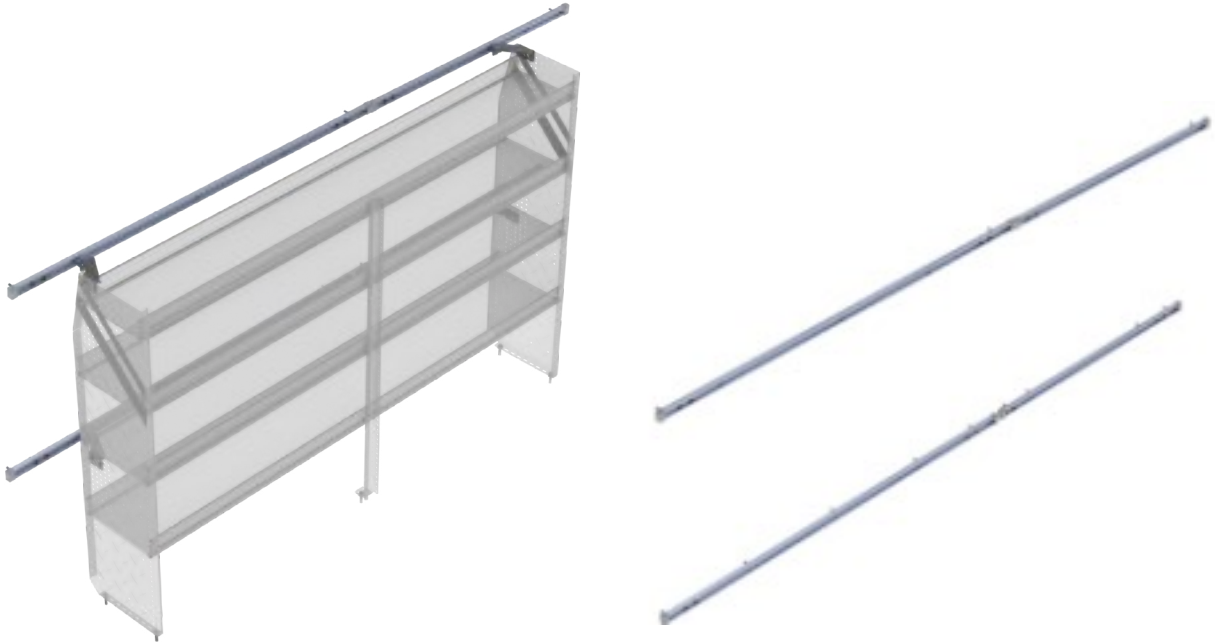

VAN UPFIT PREP



Install kits are optional and sold without the shelving unit

6550-FTL SHOWN HERE.

### Install Kit – Driver

PART	VEHICLE		DESCRIPTION			
6550-FTL	FORD TRANSIT	148"	Shelving install kit, driver side	13 lbs	0.3 hr	Yes
6550-FTS	FORD TRANSIT	130"	Shelving install kit, driver side	12 lbs	0.3 hr	Yes
6550-FTX	FORD TRANSIT	148" Ext	Shelving install kit, driver side	16 lbs	0.3 hr	Yes
6550-PL	RAM PROMASTER	159"	Install track kit, driver side	13 lbs	0.5 hr	Yes
6550-PM	RAM PROMASTER	136"	Install track kit, driver side	11 lbs	0.5 hr	Yes
6550-PS	RAM PROMASTER	118"	Install track kit, driver side	8.9 lbs	0.5 hr	Yes
6550-PX	RAM PROMASTER	159" Ext	Install track kit, driver side	14 lbs	0.5 hr	Yes







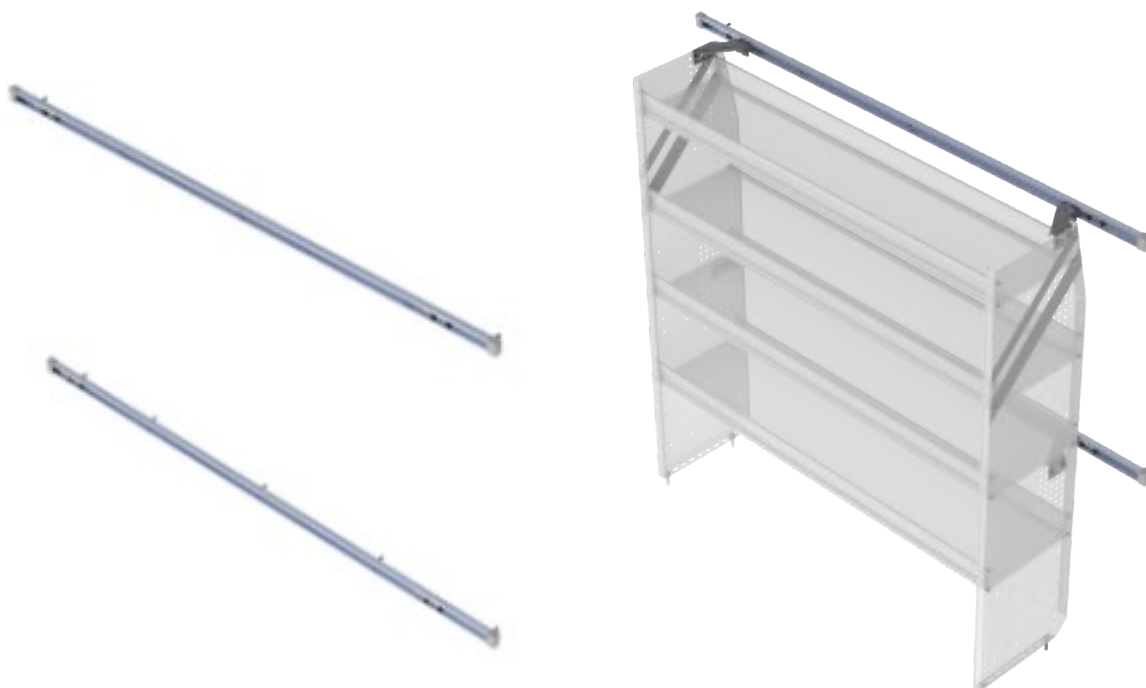

# VAN UPFIT PREP – INSTALL KITS



6555-FTL SHOWN HERE.

Install kits are optional and sold without the shelving unit

Install Kit – Passenger						
PART	VEHICLE	 Wheelbase	DESCRIPTION	 Weight	 Estimated Install Time	 Quickship
6555-FTL	FORD TRANSIT	148"	Shelving install kit, passenger side	7.7 lbs	0.4 hr	Yes
6555-FTS	FORD TRANSIT	130"	Shelving install kit, passenger side	6 lbs	0.4 hr	Yes
6555-FTX	FORD TRANSIT	148" Ext	Shelving install kit, passenger side	11 lbs	0.4 hr	Yes
6555-PL	RAM PROMASTER	159"	Shelving install kit, passenger side	7.5 lbs	0.3 hr	Yes
6555-PM	RAM PROMASTER	136"	Shelving install kit, passenger side	5.5 lbs	0.3 hr	Yes
6555-PS	RAM PROMASTER	118"	Shelving install kit, passenger side	4.5 lbs	0.3 hr	Yes
6555-PX	RAM PROMASTER	159" Ext	Shelving install kit, passenger side	8.6 lbs	0.3 hr	Yes

